

24" DEEP BACK BAR COOLER



EBB69-24

EBB Series



Refrigeration System

- Side mounted, self-contained and fully detachable Blizzard R290 condensing unit uses environmentally friendly, EPA-compliant R290 refrigerant with zero (0) Ozone Depletion Potential (ODP) and three (3) Global Warming Potential (GWP). Blizzard R290 is easily replaceable and requires no on-site brazing.
- Electronically commutated (ECM) fan motors achieve rapid cooling with less energy consumption.
- Full-length air duct ensures optimal cold air circulation.
- Time-initiated and temperature-terminated auto defrost cycle for seamless operation.
- Large capacity, corrosion-resistant condenser and evaporator coils.
- Self-maintaining, energy-efficient condensate drain pan requires no external drains or electric heaters.
- High performance, auto-reverse condenser fan motor supports compressor ventilation and condenser coil cleaning.
- Pre-wired and ready to plug, 115V/60Hz/1Ph, NEMA 5-15P.

Cabinet Construction

- Heavy duty stainless steel countertop with textured laminate, black vinyl exterior.
- Open spaced interior with no walls between compartments.
- Galvanized steel interior walls and high quality stainless steel floor.
- 1 3/4" thick high density polyurethane insulation.
- Built-in caster thread receptacles.

Lighting

- Shielded LED bar lighting with on/off switch provides bright, high color illumination at lower heat output.

Doors

- Textured laminate, black vinyl exterior with galvanized steel interior.
- 1 3/4" thick high density polyurethane insulation.
- Snap-in magnetic door gasket make cleaning and replacement an easy process.
- High strength, recessed door handles.
- Pre-installed door locks keep your items safe from theft.

Shelving

- Two epoxy coated, steel wire shelves per section.
- Height adjustable stainless steel clips.

Temperature Control

- Multi-function digital controller with easy to read LED display.
- Factory preset temperature, 35°F.
- Temperature setting range from 33°F to 54°F.
- Audible overheat protection alarm for compressor and condenser coil.

Options

- Additional shelving.
- 3" or 5" swivel casters with locks.
- 3.5" – 6" height-adjustable and interchangeable legs.



Type	Doors	Capacity Cu. Ft.	12 oz. Cans	12 oz. Bottles	Shelves	Refrigerant	HP	Power V-Hz-Ph	Amps	Crated Weight	Exterior Dimensions		
											L	D	H*
REF	2	20	700	441	4	R-290	1/4+	115-60-1	3.5	301 lbs	68"	24.5"	37.25"

(†)Based on evaporating temperature of 23°F (-5°C) & condensing temperature of 131°F (55°C). (‡) Product capacity is calculated based on standard industry figures. (*) Reference plan view for clarification on caster/unit height. If dimensions and capacity are critical, please contact Everest Refrigeration. Blizzard R290 replacement is at the sole discretion of Everest Refrigeration. Specifications subject to change without notice.

24" DEEP BACK BAR COOLER



EBB69-24

EBB Series

DIMENSIONAL DATA

External Dims.	L	68 in.
	D	24.5 in.
	H*	37.25 in.
Crated Weight	301 lbs.	
Doors/Drawers/Lids	2	
Max Weight Support	-	

STORAGE DATA

Net Capacity Cu. Ft. †	20
Shelves	4
Barrels	-
20 oz. Bottles	-
12 oz. Bottles	441
12 oz. Cans	700
8" Mugs	-
# of Pans (Top)	-
# of Pans (Drawer)	-
Dividers	-
Trays	-

ELECTRICAL DATA

Voltage	115-60-1
Full Load Amperage	3.5A
Feed Wires w/ Ground	3
Cord Length	9ft
NEMA Plug Type	NEMA 5-15P

REFRIGERATION DATA

Compressor	Side
Refrigerant	R-290
Compressor HP	1/4+
BTU/HR †	1926

KEY

D	Door	R	Refrigerator
L	Lid	REF	Refrigerator
H	Half Door	F	Freezer
FD	Full Door	FRZ	Freezer
SD	Solid Door	DUAL	REF/FRZ Combo
GD	Glass Door	DR	Drawer

	Elevation	Right	Plan	3D	Back

PLAN VIEW

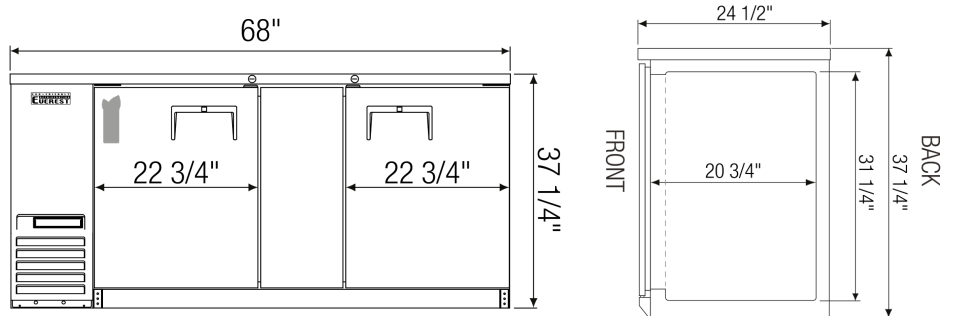

FRONT

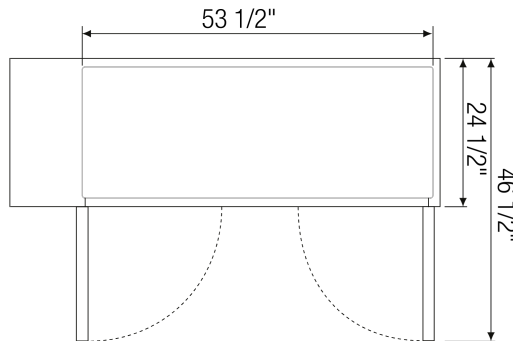

TOP

SIDE

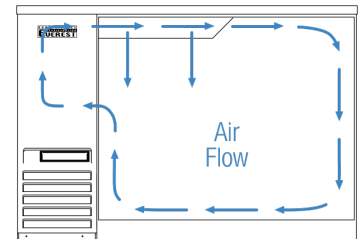

AIRFLOW

ACCESSORIES & OPTIONS

- Additional Shelving - Contact Everest Refrigeration for more information.
- AJL03-00 - Interchangeable Leg for Caster (Optional)
- CASA3-01 - 3" Overall Height Caster Assembly - (2) Front (2) Rear
- CASA5-01 - 5" Overall Height Caster Assembly - (2) Front (2) Rear

(†)Based on evaporating temperature of 23°F (-5°C) & condensing temperature of 131°F (55°C). (‡) Product capacity is calculated based on standard industry figures. (*) Reference plan view for clarification on caster/unit height. If dimensions and capacity are critical, please contact Everest Refrigeration. Blizzard R290 replacement is at the sole discretion of Everest Refrigeration. Specifications subject to change without notice.